

MULTI CABLE TRANSITS



INDEX

General			
Benefits and features	4	RGPM (high pressure)	29
Calculation program	5	RGPH (high pressure)	30
		RFCS cabinet seal	31
		SR cable and pipe seals	32
Blocks			
Insert blocks	6	MSR glands	33
Handiblocks	9	Deck & bulkhead glands	34
Add blocks	10	Accessories	36
U-blocks	11		
EMC blocks	12	References	
ATEX blocks	15	Projects	40
Special blocks	16		
3 phase blocks	17		
Frames			
RGS (welding)	18		
RGP (round)	22		
RGB en RGBO (casting)	25		
RGGOK (bolt-on)	28		



THEUNISSEN TECHNICAL TRADING BRANDS



LIGHTING ON BOARD

Technical | Navigation | EX | LED assortment | Floodlights



PIPE- AND CABLE TRANSITS

Water- and gastight | EMC | ATEX



COMMUNICATION ON BOARD

Telephone | Intercom | PA | GA | EX | Wireless

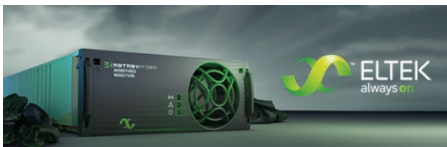

ELTEK POWER CONVERSION

UPS | Rectifiers | Inverters | Battery banks



FIRE DETECTION

Complete systems | Conventional | Adressable



REVERSE OSMOSIS WATERMAKERS

650 - 1.200.000L a day



SEARCHLIGHTS

Halogen | Xenon | LED



SINGLE PIPE- AND CABLE TRANSITS

ASTM | DIN | DH-AP | PVC



LOUDSPEAKERS

Horn | Cabinet | Music | Ceiling | Projector | Voice Alarm | Clean Room | EN54-24 | EX



EMERGENCY TELEGRAPHS

two wire based

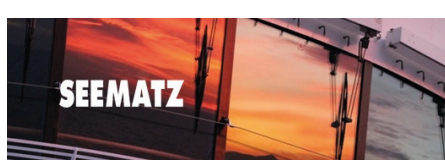

WINDOW WIPERS

straightline wipers, custom sizes



SIGNAL COLUMNS

Configurable as desired

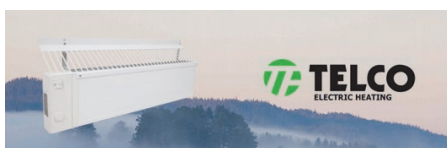

MARINE HEATERS

Elektrical | IP44 | 250-2000W

WHY MCT BRATTBERG CABLE TRANSITS?

The MCT Brattberg cable transit systems are designed to allow safe passage of cables through steel hulls and through concrete walls. Our cable transit systems range from singular cables to complex situations with a lot of similar cables, like internal passageways onboard. The most important characteristics of the MCT Brattberg system are:

- Proven sealing system (about 70 years) for multiple cables and pipes
- Controllable system, reduces error probability during assembly
- Protection against pressure (up to 5.5 bar), water, gas, smoke, explosions (up to 27 bar), vibrations, noise, radioactive radiation, vermin and rats
- Fire retardant (EN 1366 tested, A0, A60, H120)
- Pre-greased blocks: simplifies and speeds up assembly and increases safety
- Very large assortment standard in stock
- MCT Brattberg has been tested and certified by almost all classification societies
- Guaranteed lifespan of 25 years, when correctly installed



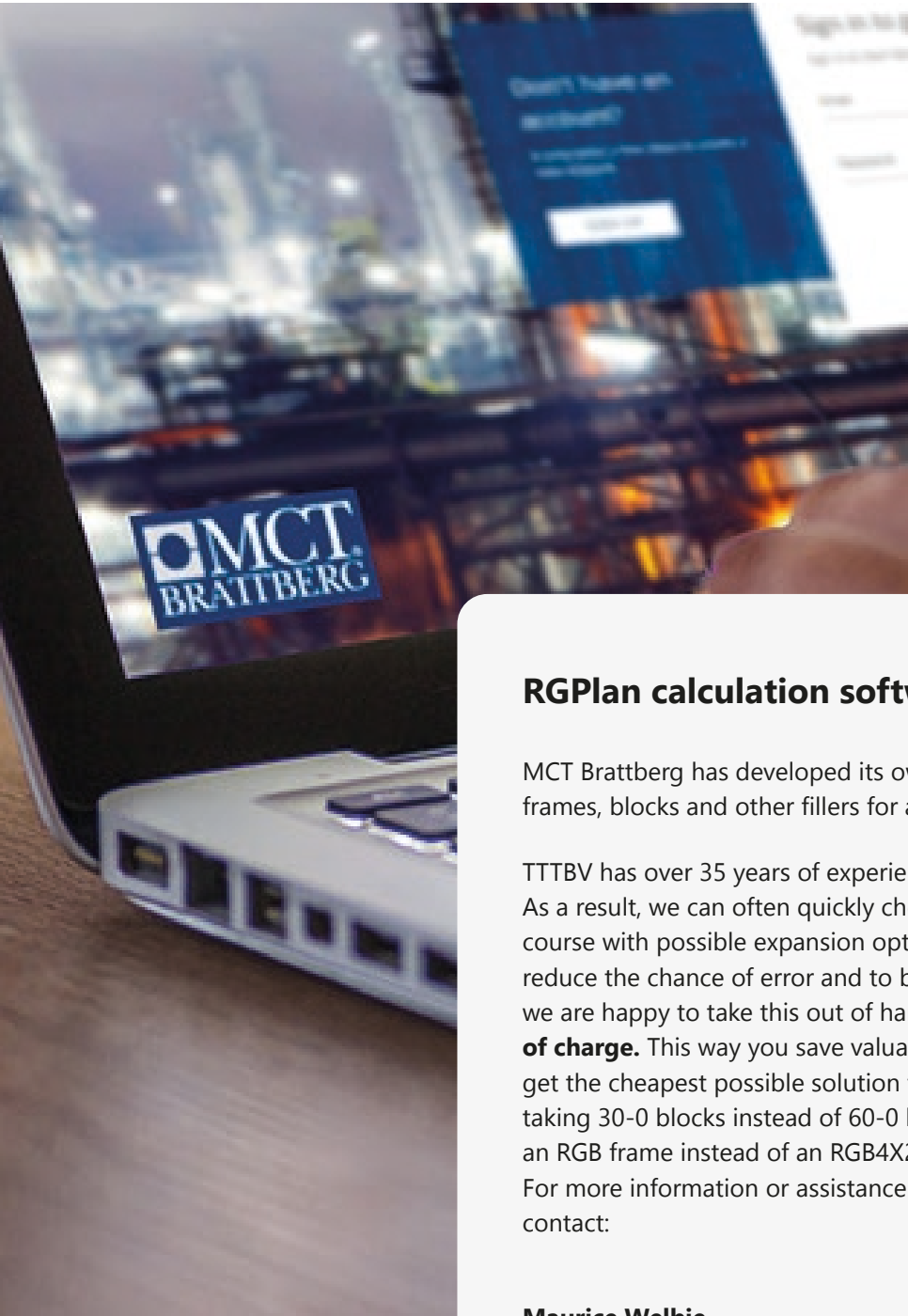

RGPlan calculation software

MCT Brattberg has developed its own tool for calculating the required frames, blocks and other fillers for a cable penetration; RGPlan.

TTTBV has over 35 years of experience with the transits of MCT Brattberg. As a result, we can often quickly choose the most cost-efficient solution, of course with possible expansion options for the future. In order to further reduce the chance of error and to be able to work quickly and efficiently, we are happy to take this out of hand and do the calculation for you **free of charge**. This way you save valuable time and we ensure that you also get the cheapest possible solution for your situation. An example of this is taking 30-0 blocks instead of 60-0 blocks as filler blocks or the choice of an RGB frame instead of an RGB4X2.

For more information or assistance with calculating with RGPlan, please contact:

Maurice Welbie

m.welbie@tttbv.com

+31 (0)24-3667472

Insert blocks

The range of pre-greased insert blocks from MCT Brattberg is suitable as standard for the passage of cables and pipes with a diameter of 4 to 100mm. It is important here that the insert block is accurately adjusted to the outer diameter of the cable to be fed through.

The cable diameters must therefore always be carefully measured so that the matching insert blocks are chosen for each cable. On the basis of the dimension tables * it can be verified whether the correct block size has been chosen for the cable concerned; the diameter code on the block gives immediate clarity at this point.

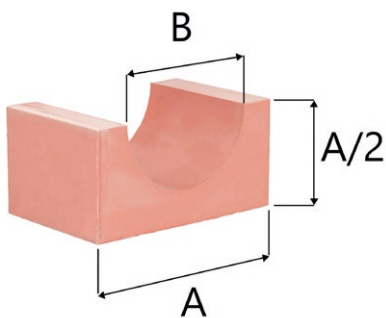
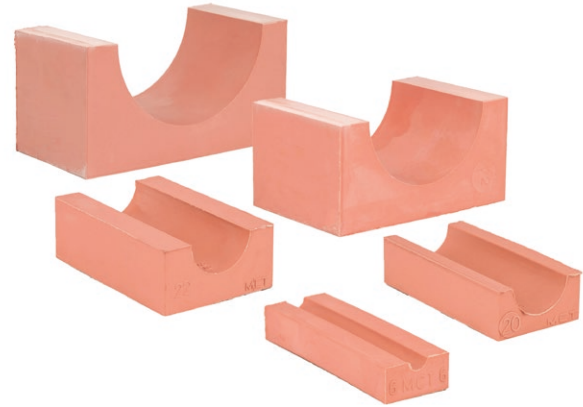

The depth of an insert block is always 60mm. For each cable, two insert blocks must be used at all times in order to be able to seal that cable.

Blocks are indicated with their width (A) and diameter (B).

A block with a width of 15 mm and a hole size of 4 mm thus becomes shown as 15/4.

Blind bloks

In addition to the standard insert blocks for cable sealing, blind blocks also exist. Blind blocks are dense standard blocks, square and always 60mm deep. At the location of the blind blocks, cables can still be implemented at a later stage.

*next pages

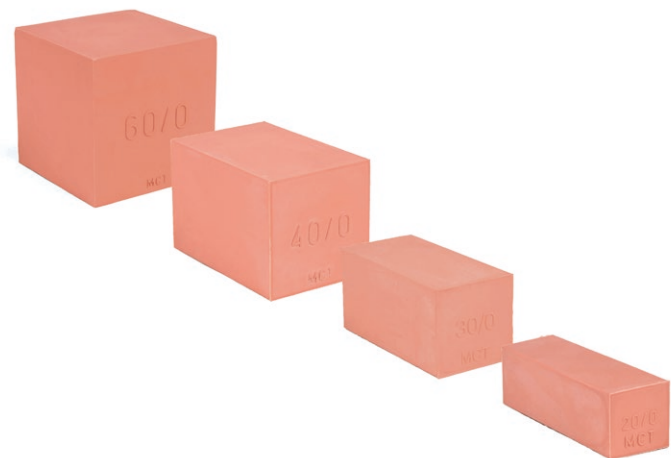

Diameter coding insertblocks

Cable dia.	15	20	30	40	60	80	90	B	Cable dia.	80	90	120	B
3.5-4.5	15-04	20-04						4	55.5-57.5	80-56	90-56		56
4.5-5.5	15-05	20-05						5	57.5-59.5	80-58	90-58		58
5.5-6.5	15-06	20-06						6	59.5-61.5	80-60	90-60		60
6.5-7.5	15-07	20-07						7	61.5-63.5	80-62	90-62		62
7.5-8.5	15-08	20-08						8	63.5-65.5	80-64	90-64		64
8.5-9.5	15-09	20-09						9	65.5-67.5	80-66	90-66		66
9.5-10.5		20-10						10	67.5-69.5	80-68	90-68		68
10.5-11.5		20-11						11	69.5-71.5	80-70	90-70		70
11.5-12.5		20-12	30-12					12	71.5-73.5			120-72	72
12.5-13.5		20-13	30-13					13	73.5-75.5			120-74	74
13.5-14.5		20-14	30-14					14	75.5-77.5			120-76	76
14.5-15.5		20-15	30-15					15	77.5-79.5			120-78	78
15.5-16.5		20-16	30-16					16	79.5-81.5			120-80	80
16.5-17.5			30-17					17	81.5-83.5			120-82	82
17.5-18.5			30-18					18	83.5-85.5			120-84	84
18.5-19.5			30-19					19	85.5-87.5			120-86	86
19.5-20.5			30-20					20	87.5-89.5			120-88	88
20.5-21.5			30-21					21	89.5-91.5			120-90	90
21.5-22.5			30-22	40-22				22	91.5-93.5			120-92	92
22.5-23.5			30-23	40-22				23	93.5-95.5			120-94	94
23.5-24.5			30-24	40-23				24	95.5-97.5			120-96	96
24.5-25.5				40-24				24	97.5-99.5			120-98	98
25.5-27.5				40-26				26	99.5-101.5			120-100	100
27.5-29.5				40-28				28					
29.5-31.5				40-30				30					
31.5-33.5				40-32	60-32			32					
33.5-35.5				40-34	60-34			34					
35.5-37.5					60-36			36					
37.5-39.5					60-38			38					
39.5-41.5					60-40			40					
41.5-43.5					60-42			42					
43.5-45.5					60-44			44					
45.5-47.5					60-46			46					
47.5-49.5					60-48			48					
49.5-51.5					60-50		90-50	50					
51.5-53.5					60-52		90-52	52					
53.5-55.5					60-54	80-54	90-54	54					

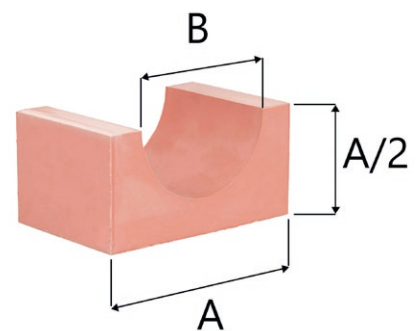

Blocks are indicated with their width (A) and diameter (B).

A block with a width of 15 mm and a hole size of 4mm thus becomes shown as 15-04.

BLOCKS

Weight in grams per block (insertblock is half of square)							
Block	Weight	Block	Weight	Block	Weight	Block	Weight
24x15-0	58	20-04	18	40-22	57	90-50	287
12x10-0	113	20-05	18	40-24	54	90-52	279
15-0	20	20-06	13	40-26	50	90-54	273
20-0	38	20-07	12	40-28	47	90-56	262
30-0	84	20-08	11	40-30	42	90-58	255
40-0	150	20-09	10	40-32	37	90-60	243
60-0	338	20-10	9	40-34	32	90-62	239
90x30-0	279	20-11	36	60-32	131	90-64	229
15-04	10	20-12	36	60-34	127	90-66	220
15-05	10	20-13	35	60-36	122	90-68	211
15-06	10	20-14	34	60-38	116	90-70	204
15-07	10	20-15	33	60-40	110	120-72	494
15-08	9	20-16	31	60-42	104	120-74	485
15-09	8	30-12	30	60-44	98	120-76	472
		30-13	28	60-46	91	120-78	462
		30-14	27	60-48	84	120-80	448
		30-15	25	60-50	77	120-82	437
		30-16	24	60-52	59	120-84	425
		30-17	22	60-54	61	120-86	415
		30-18	30	80-54		120-88	403
		30-19	28	80-56		120-90	385
		30-20	27	80-58		120-92	368
		30-21	25	80-60		120-94	360
		30-22	24	80-62		120-96	351
		30-23	22	80-64		120-98	332
		30-24	21	80-66		120-100	313
				80-68		120-108	243

COMPONENTS

STG

Installed between compression plate and the top of the frame, completing the seal. Made of Lycron with galvanized or stainless steel fittings.



Compression plate (COMPPLA)

Most of the time mounted above the upper row blocks. The plate bolt is tightened to compress blocks around cables, providing space for STG endpacking. Available in composite (standard) or galvanized steel (EMC)

PTG

Can be used as an alternative to compression plate and STG. Can also be placed anywhere in the list. Made from Lycron, with stainless steel fittings.



HANDBLOCK

Handiblock

A safe, flexible and easily tailored sealing block for cables and pipes. Due to the large range per basic block, a large number of different cable and / or pipe diameters can be sealed with only one block. The HandiBlock is available in four sizes for cables and pipes from 4 to 54 mm.

The HandiBlock is ordered as a complete block, consisting of two basic blocks (Main blocks),



Artnr	Cable diameter
HB-20	4 - 15 mm
HB-30	11 - 24 mm
HB-40	21 - 35 mm
HB-60	32 - 54 mm

two InsertStrips and an (optional) Handplug. In this way a Handiblock can be used as both a flexible insert block, for sealing a cable or pipe, or as a (temporary) blind block.

Present HandiBlocks equipped with a HandiPlug, which originally function as a blind block, can easily be reused at a later stage for the transmission of a cable or pipe. To this end, only after partial disassembly of the window, the plug needs to be removed and the InsertStrips must be adapted to the measured diameter of the cable or pipe to be fed through.

The HandiBlocks can be used in combination with all other types of MCT Brattberg blocks, such as InsertBlocks, blind blocks, U-Blocks and AddBlocks. By using original parts in the throughput, this remains a certified solution, even after reinstallation.

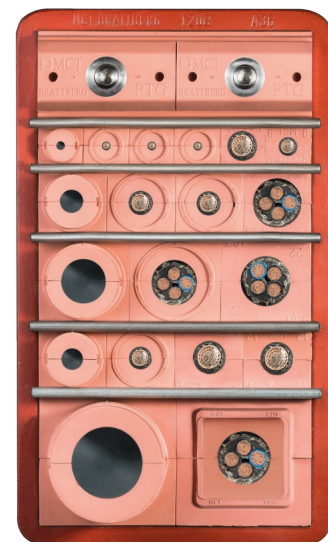

ADDBLOCK

Add-blocks

MCT Brattberg has, in addition to the familiar insert blocks, also a flexible transit block in its range: the AddBlok.

With only one AddBlok you are able to seal 5 different cable diameters. An ideal product if you do not know exactly in advance which cables you have to implement, for example for repair projects, at a temporary location or abroad.



The AddBlok is very easy to apply:

- The AddBlok is very flexible, even incorrect choice block size can be restored without any problem
- The AddBlocks can be delivered from stock within 24 hours
- The inserts are anchored in the block, so that sliding away is not possible
- The AddBlok has all the known advantages of the existing MCT Brattberg system
- The Add Blocks are also pre-lubricated
- Working with AddBlocks during installation is verifiable: all sizes are indicated on each insert
- With plugs and wraps, a window filled with AddBlocks can be temporarily closed (for example, to be able to supply cables at a later stage)

AddBlock	Cable diameter
20/4-8	3,5 - 8,5 mm
20/9-13	8,5 - 13,5 mm
30/14-18	13,5 - 18,5 mm
30/19-23	18,5 - 23,5 mm
40/24-28	23,5 - 28,5 mm
40/29-33	28,5 - 33,5 mm
60/34-38	33,5 - 38,5 mm
60/39-43	38,5 - 43,5 mm
60/44-48	43,5 - 48,5 mm
90/50-58	49,5 - 59,5 mm
90/60-68	59,5 - 69,5 mm

Cables from 3,5 to 69,5mm

Currently, eleven different AddBlocks are available, with which cables from 3.5 to 69.5 mm can be sealed. Each block can seal five different diameters.

In the series 90 / .. a tolerance of - 0.5 mm / + 1.5 mm is maintained, whereby with one block of cables with 10 consecutive diameters can be sealed in mm.

U-blocks

A U-Block is a block that can be placed around a standard insert block. This increases the outside size of the original block. In this way, a cable in a small insert block, for example 20x20mm, can easily be placed next to a larger cable in a 30x30mm insert block. Thick and thinner cables can be easily placed in one block row without the need for multiple spacer strips.



Advantages of the U-blocks:

- It is possible to place different sizes of insert blocks in one row
- By building a larger blind block from a small blind block with one or more U-blocks, the entire blind space does not always have to be replaced when adding a cable later.
- A cable or pipe can always be placed centered in an RGP
- Made from pre-greased rubber
- Equipped with clear customized coding

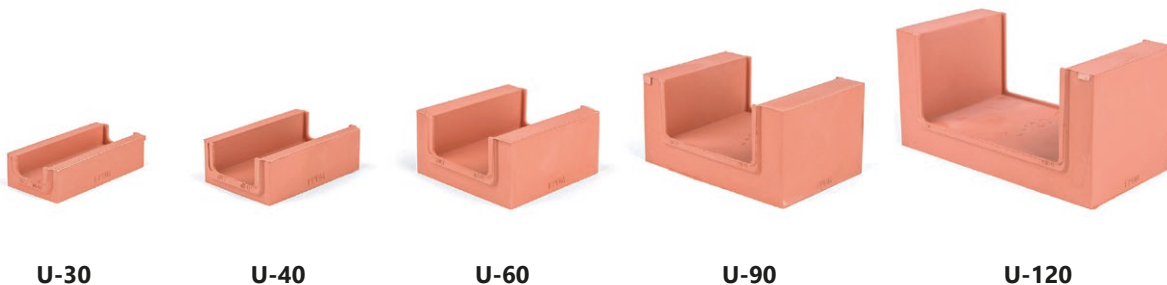

U-30

U-40

U-60

U-90

U-120

EMC cable transits

There are magnetic fields around cables and other conductors, which can lead to induction. Lightning strikes or nuclear explosions are also sources of induction. This inductance can lead to interfering electrical charge on nearby cables. This charge on the cables can seriously disrupt the associated equipment.

EMC cable glands, also called E-MCT, protect equipment against such EMI influences by leading them away to earth via the grommet and thus keeping them completely outside the protected room or cabinet.

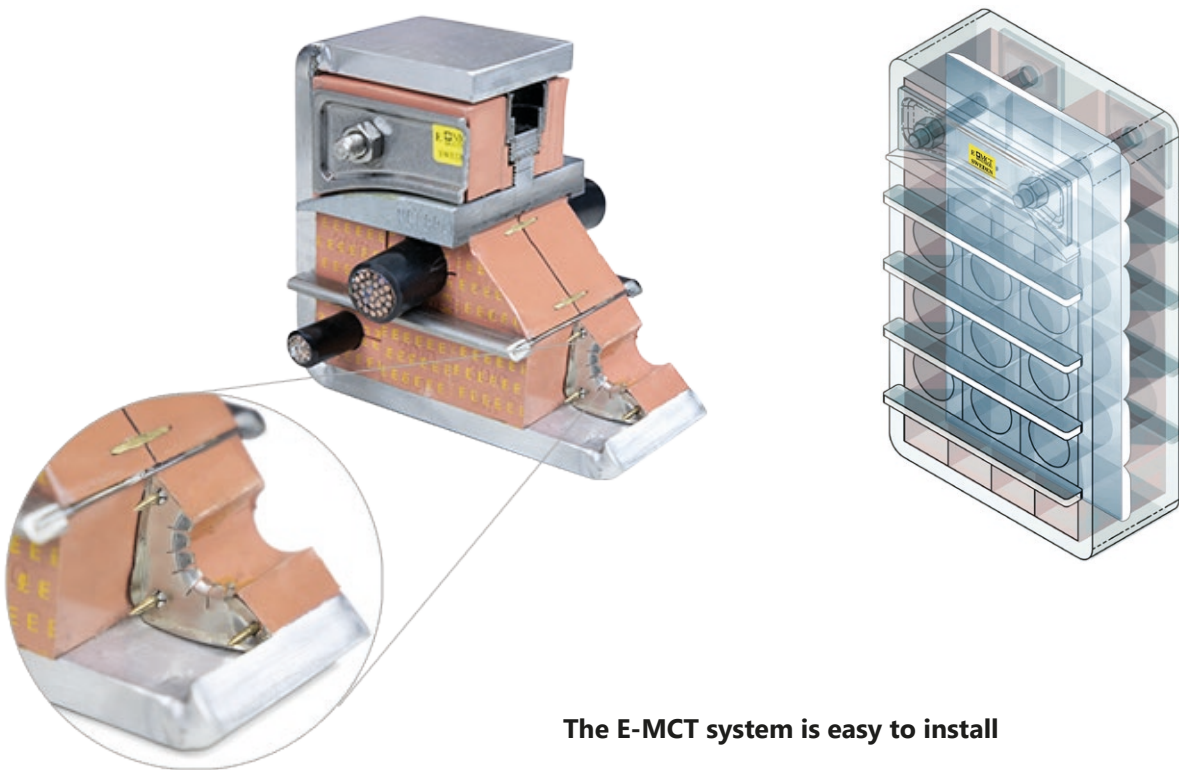

The E-MCT system is easy to install

- Measure the diameter of the cable
- Determine which E-MCT block is suitable for this
- Peel the cable up to the earth screen so that approx. 1 cm. (lengthwise) of the jacket can be removed
- Place the cable in the E-MCT block so that the conductive material in the block makes contact with the cable ground screen
- Fill the stainless steel frame with E-MCT materials and close the penetration with a conductive sealing block

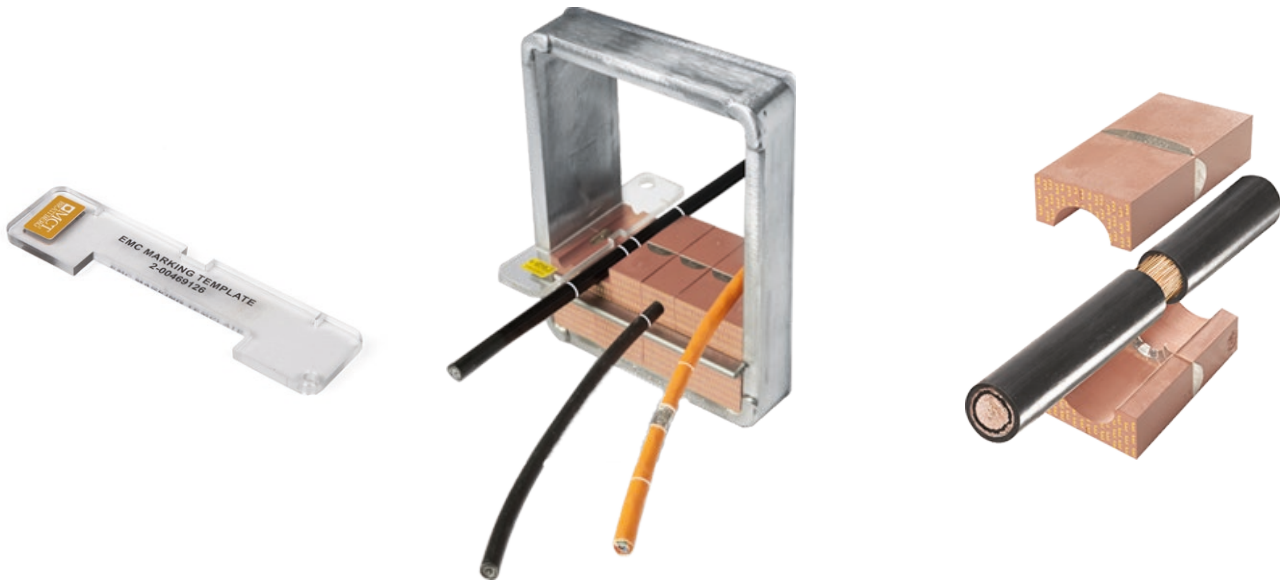

EMC Marking tool

MCT Brattberg has developed a tool especially for stripping cables with EMC shielding for the feedthrough, which allows you to always strip the outer layer of the cable in exactly the right place before threshing. It is essential that the shield of the cable makes good contact with the shield in the blocks. In addition, other, non-EMC specific, accessories and tools are available for installing the transit as quickly and efficiently as possible.



30-0E



20-04-08E



TWEEZER

The same advantages as other MCT Brattberg products:

- A60 certified by Lloyds Register and DNV
- EN-1366 tested against fire penetration (Class A0, A60, H0, H60, H120)
- Certified up to 5,5 bar
- Resistant against gas, explosion, water, dust, vermin etc.
- Verifiable (measurements indicated on the outside)

EMC BLOCKS

Diameter coding insertblocks

Cable dia.	15	20	30	40	60	80	90	B	Kabel dia.	80	90	120	B
3.5-4.5	15-04E	20-04E						4	55.5-57.5	80-56E	90-56E		56
4.5-5.5	15-05E	20-05E						5	57.5-59.5	80-58E	90-58E		58
5.5-6.5	15-06E	20-06E						6	59.5-61.5	80-60E	90-60E		60
6.5-7.5	15-07E	20-07E						7	61.5-63.5	80-62E	90-62E		62
7.5-8.5	15-08E	20-08E						8	63.5-65.5	80-64E	90-64E		64
8.5-9.5	15-09E	20-09E						9	65.5-67.5	80-66E	90-66E		66
9.5-10.5		20-10E						10	67.5-69.5	80-68E	90-68E		68
10.5-11.5		20-11E						11	69.5-71.5	80-70E	90-70E		70
11.5-12.5		20-12E	30-12E					12	71.5-73.5			120-72E	72
12.5-13.5		20-13E	30-13E					13	73.5-75.5			120-74E	74
13.5-14.5		20-14E	30-14E					14	75.5-77.5			120-76E	76
14.5-15.5		20-15E	30-15E					15	77.5-79.5			120-78E	78
15.5-16.5		20-16E	30-16E					16	79.5-81.5			120-80E	80
16.5-17.5			30-17E					17	81.5-83.5			120-82E	82
17.5-18.5			30-18E					18	83.5-85.5			120-84E	84
18.5-19.5			30-19E					19	85.5-87.5			120-86E	86
19.5-20.5			30-20E					20	87.5-89.5			120-88E	88
20.5-21.5			30-21E					21	89.5-91.5			120-90E	90
21.5-22.5			30-22E	40-22E				22	91.5-93.5			120-92E	92
22.5-23.5			30-23E	40-22E				23	93.5-95.5			120-94E	94
23.5-24.5			30-24E	40-23E				24	95.5-97.5			120-96E	96
24.5-25.5				40-24E				24	97.5-99.5			120-98E	98
25.5-27.5				40-26E				26	99.5-101.5			120-100E	100
27.5-29.5				40-28E				28					
29.5-31.5				40-30E				30					
31.5-33.5				40-32E	60-32E			32					
33.5-35.5				40-34E	60-34E			34					
35.5-37.5					60-36E			36					
37.5-39.5					60-38E			38					
39.5-41.5					60-40E			40					
41.5-43.5					60-42E			42					
43.5-45.5					60-44E			44					
45.5-47.5					60-46E			46					
47.5-49.5					60-48E			48					
49.5-51.5					60-50E		90-50E	50					
51.5-53.5					60-52E		90-52E	52					
53.5-55.5					60-54E	80-54E	90-54E	54					

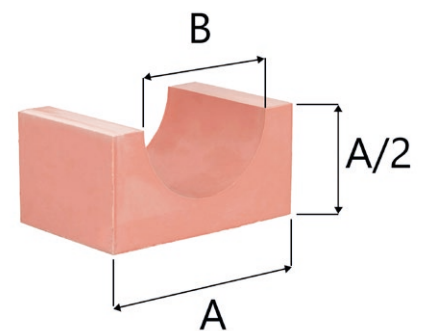

Blocks is indicated with their width (A) and diameter (B).

A block with a width of 15 mm and a hole size of 4 mm thus becomes shown as 15/4.

EMC BLOCKS

Weight in grams per block					
Block	Weight	Block	Weight	Block	Weight
24 x 5/0E	58	30-12E	30	60-44E	98
12 x 10/0E	113	30-13E	28	60-46E	91
15-0E	20	30-14E	27	60-48E	84
20-0E	38	30-15E	25	60-50E	77
30-0E	84	30-16E	24	60-52E	59
40-0E	150	30-17E	22	60-54E	61
60-0E	338	30-18E	30	90-50E	287
15-4E	10	30-19E	28	90-52E	279
15-5E	10	30-20E	27	90-54E	273
15-6E	10	30-21E	25	90-56E	262
15-7E	10	30-22E	24	90-58E	255
15-8E	9	30-23E	22	90-60E	243
15-9E	8	30-24E	21	90-62E	239
20-4E	18	40-22E	57	90-64E	229
20-5E	18	40-24E	54	90-66E	220
20-6E	13	40-26E	50	90-68E	211
20-7E	12	40-28E	47	90-70E	204
20-8E	11	40-30E	42		
20-9E	10	40-32E	37		
20-10E	9	40-34E	32		
20-11E	36	60-32E	131		
20-12E	36	60-34E	127		
20-13E	35	60-36E	122		
20-14E	34	60-38E	116		
20-15E	33	60-40E	110		
20-16E	31	60-42E	104		

EX transits

For situations where MCT Brattberg transits have to be placed in an explosive environment, MCT Brattberg has developed a special line of IEC-Ex and ATEX approved frames and filling materials. All rubber filling materials for the EX transits are provided with a special green marking. All Ex certified MCT Brattberg products are suitable for both Zone 1 and Zone 2.

MCT Brattberg's Ex products are approved by DNV-GL and meet the quality and environmental standard requirements of ISO 9001, 14001 and OHSAS 18001, also meet ATEX directive 2014/34 / EC and IECEx requirements.



Marking

The ATEX directive requires the product to be marked with the CE mark, the EX mark and the equipment coding.

II2GD Ex eb IIC Gb Ex tb IIIC Db T -60.c to +70.c

- II = Surface and mining
- 2 = Zone 1/21 (1=Gas 21=Dust)
- GD = Gas & Dust
- Ex eb = Increased safety, b=zone 1,2
- IIC = All gases approved
- Gb = Gas zone 1 (Zone 1 is also approved in zone 2. NOT ZONE 0)
- Ex tb = Dust enclosure 6 (IP)
- IIIC = Conductive dust, also approved for A and B. ombustible flyings, B=none-conductive dust.
- Db = Zone 21, dust also zone 22
-60.c to +70.c = Ex working temp min/max

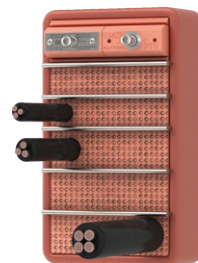

WELDING

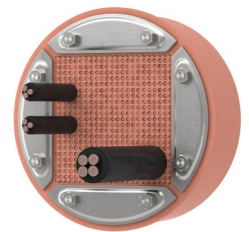

BUILT-IN (+SLEEVE)



BOLTING



BOLTING

We are happy to advise you for your specific explosive situations. For more information, please contact **Maurice Welbie** via m.welbie@tttbv.com or +31(0)24 358 4455.

Special blocks

In some situations there is a desire for special versions of blocks, in order to realize a suitable seal. For example, a cable is sometimes not round, but oval, triangular (sectoral) or hexagonal.

Special blocks are for example for:

- Multiple cables on a small surface
- 3 phase cables in a triangle formation
- Cables with special shape
- Wave guides, oval fiber tubes
- Double cables (twin cable).

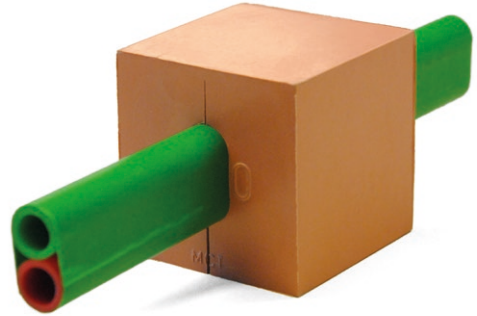

MCT Brattberg has many special solutions already available. It is also possible to produce custom-made blocks based on the measurement of a sample cable.

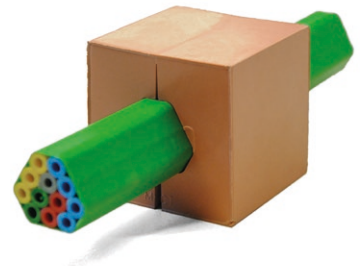
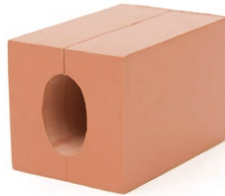

Three phase block

MCT Brattberg has, in addition to the familiar insert blocks, a special feed-through block for the sealing of 3 separate phase cables: the 3-phase block.

The installation of single-core power cables should be done in a fixed triangular formation. This is necessary to prevent a magnetic field and thus undesirable interference. The three cables can be placed in standard insert blocks, with the remaining space being filled with blind blocks. A more efficient way to achieve the triangle formation is the specially developed 3 phase block. The cables are fed into one block.



In the 3-phase block, cables can be fed with a diameter of 34 mm to 40 mm, with the outer dimension of the combination block remaining 90x90 mm.

RGS welding frames

MCT Brattberg has more than 60 years of experience in the development of high-quality cable and pipe penetrations. Basically, the system consists of transit windows and filling material, tailored to the quantity and size of cables and pipes to be fed through. The different types of RGS frames are intended for use in steel or aluminum walls. The RGS frame is fitted as standard in a pre-cut hole in the deck or the wall (bulkhead).

Apart from 4 height units (type 2, 4, 6 and 8) there are multiple windows, allowing expansion in horizontal and vertical direction. RGS windows are supplied in steel, stainless steel and aluminum. Also delivery in specially classified steel is possible, among others EH-36.



RGS6P

RGS	Welding window, the most used window type for maritime applications.
RGSO	As RGS, but with removable end part (if cables already present).
RGSF	requires less precision to be welded or can be bolted without welding (type RGSFB).
RGSC	A window with rounded corners, reducing the risk of cracking in the ship's side.
RGSK	An extra deep window intended for use on outside decks
RGSR	Intended for locations where there is extreme load.
RGSbtb	A double penetration with intermediate chamber, which is pressure-tight on both sides. Resistant to 'jet-fire' (the RGSbtB can also be used for the possibility to test for pressure resistance on location).



RGS



RGSO



RGSF



RGSC



RGSK



RGSR



RGSbtb

Dimensions

The RGS is a welding window with a steel thickness of 10 mm, a depth of 60 mm and standard an internal width of 120 mm. The RGS window is available in four height units: 2, 4, 6 and 8, from 100mm in steps of 60mm up to 280mm internal height.

Window combinations can be created by combining different base sizes in a combination window. This can be done in both width and height. For example, an RGB6 + 6x3 can be used, for example for a wide cable tray: a window with 6 openings with height 6 (2 high and 3 wide).

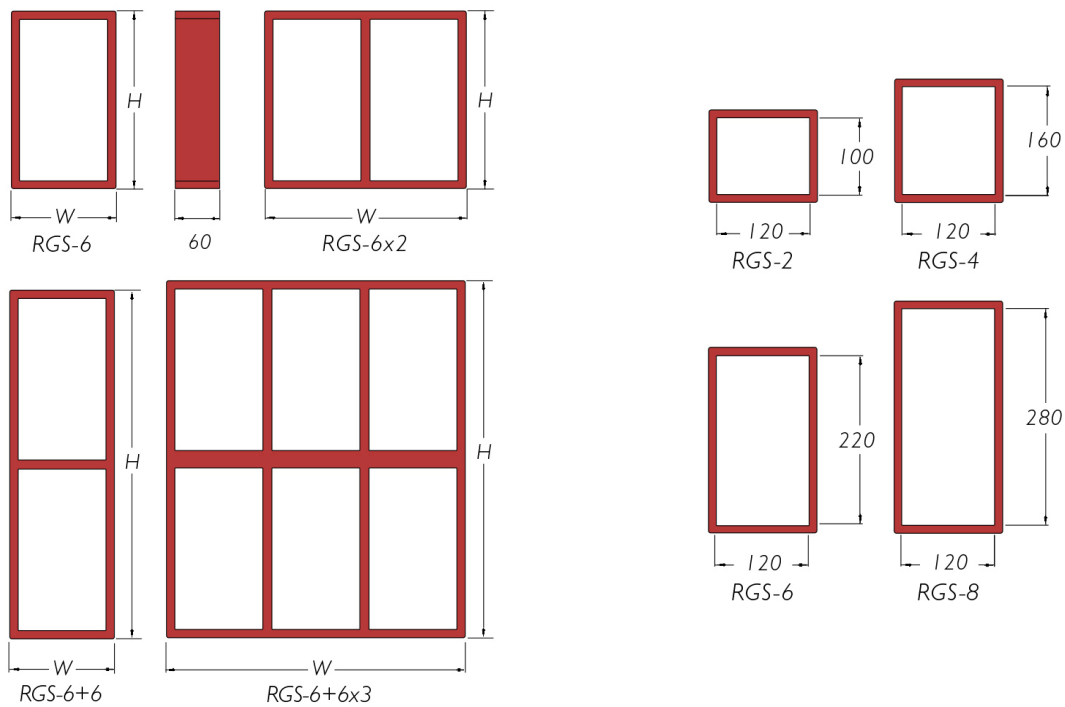

Manufacturing

MCT Brattberg produces the RGS windows under very strict conditions and welds these in two separate phases. As a result, the risk of breakage or deformation, for example as a result of tending forces in a wall, is greatly reduced. MCT Brattberg thus offers an unmatched high throughput window that can be used reliably for decades.

Sizes in mm								
Frame size	H (Height)	W (Width)/ Multiple frames						
		x 1	x 2	x 3	x 4	x 5	x 6	x a
RGS-2	121	140,5	271	401,5	532	662,5	793	W=10 + 130,5 x a
RGS-4	179,5	-''-	-''-	-''-	-''-	-''-	-''-	
RGS-6	238	-''-	-''-	-''-	-''-	-''-	-''-	
RGS-8	296,5	-''-	-''-	-''-	-''-	-''-	-''-	
RGS-2+2	242		-''-	-''-	-''-	-''-	-''-	
RGS-2+4	300,5		-''-	-''-	-''-	-''-	-''-	
RGS-2+6	359		-''-	-''-	-''-	-''-	-''-	
RGS-2+8	417,5		-''-	-''-	-''-	-''-	-''-	
RGS-4+4	359		-''-	-''-	-''-	-''-	-''-	
RGS-4+6	417,5		-''-	-''-	-''-	-''-	-''-	
RGS-4+8	476		-''-	-''-	-''-	-''-	-''-	
RGS-6+6	476		-''-	-''-	-''-	-''-	-''-	
RGS-6+8	534,5		-''-	-''-	-''-	-''-	-''-	
RGS-8+8	593		-''-	-''-	-''-	-''-	-''-	
RGS-2+2	232	140,5						
RGS-2+4	290,5	-''-						
RGS-2+6	349	-''-						
RGS-2+8	407,5	-''-						
RGS-4+4	349	-''-						
RGS-4+6	407,5	-''-						
RGS-4+8	466	-''-						
RGS-6+6	466	-''-						
RGS-6+8	524,5	-''-						
RGS-8+8	583	-''-						

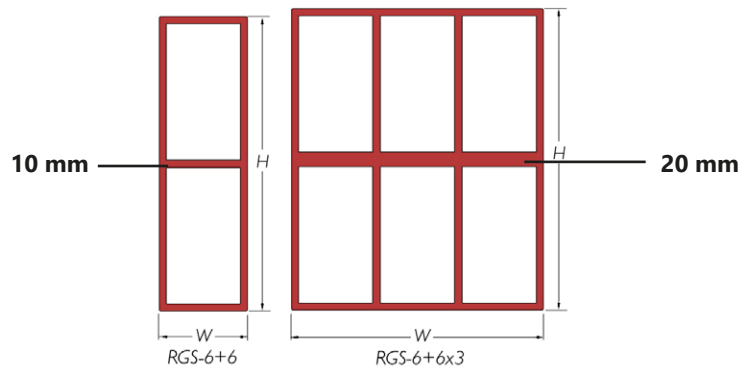

- a = number of frames in width
- Tolerance single frame: height: 1mm, width: 0.8mm
- Thickness of the material is 10 mm
- Single double frames in height, have a partition of 10mm, while the multiple have a partition of 20mm.

Weight in kilogram							
W (Width)/ Multiple frames							
Material	Frame size	1X	2X	3X	4X	5X	6X
Steel EN10025-2 S355JR 1.0045 A36	RGS-2	3,1	5,0	6,9	8,8	10,7	12,6
	RGS-4	3,8	5,9	8,1	10,2	12,4	14,6
	RGS-6	4,4	6,8	9,2	11,5	13,8	16,3
	RGS-8	5,0	7,7	10,4	13,1	15,8	18,5
	RGS-2+2	5,0	7,9	10,9	13,9	16,8	19,8
	RGS-2+4	5,6	9,0	12,4	15,7	19,1	22,4
	RGS-2+6	6,2	9,9	13,6	17,3	21,0	24,7
	RGS-2+8	6,9	11,0	15,1	19,2	23,3	27,4
	RGS-4+4	6,2	9,9	13,6	17,3	21,0	24,7
	RGS-4+6	6,9	11,0	15,1	19,2	23,3	27,4
	RGS-4+8	7,4	11,8	16,2	20,6	25,0	29,4
	RGS-6+6	7,4	11,8	16,2	20,6	25,0	29,4
	RGS-6+8	8,1	13,0	17,9	22,7	27,6	32,4
RGS-8+8	8,9	14,2	19,5	24,9	30,2	35,5	
Stainless steel EN 10088-2 1.4404 AISI 316L	RGS-2	3,2	5,1	7,1	9,0	11,0	12,9
	RGS-4	3,9	6,1	8,3	10,5	12,7	14,9
	RGS-6	4,5	6,9	9,4	11,8	14,2	16,7
	RGS-8	5,2	7,9	10,7	13,5	16,2	19,0
	RGS-2+2	5,1	8,1	11,2	14,2	17,2	20,3
	RGS-2+4	5,8	9,2	12,7	16,1	19,6	23,0
	RGS-2+6	6,3	10,1	13,9	17,8	21,6	25,4
	RGS-2+8	7,1	11,3	15,5	19,7	23,9	28,1
	RGS-4+4	6,3	10,1	13,9	17,8	21,6	25,4
	RGS-4+6	7,1	11,3	15,5	19,7	23,9	28,1
	RGS-4+8	7,6	12,1	16,6	21,1	25,6	30,1
	RGS-6+6	7,6	12,1	16,6	21,1	25,6	30,1
	RGS-6+8	8,4	13,3	18,3	23,3	28,3	33,3
RGS-8+8	9,1	14,6	20,0	25,5	31,0	36,4	
Aluminium EN 755-2 EN AW-6082	RGS-2	1,1	1,8	2,5	3,1	3,8	4,4
	RGS-4	1,4	2,1	2,9	3,6	4,4	5,1
	RGS-6	1,6	2,4	3,2	4,1	4,9	5,7
	RGS-8	1,8	2,7	3,7	4,6	5,6	6,5
	RGS-2+2	1,8	2,8	3,9	4,9	5,9	7,0
	RGS-2+4	2,0	3,2	4,4	5,5	6,7	7,9
	RGS-2+6	2,2	3,5	4,8	6,1	7,4	8,7
	RGS-2+8	2,4	3,9	5,3	6,7	8,2	9,6
	RGS-4+4	2,2	3,5	4,8	6,1	7,4	8,7
	RGS-4+6	2,4	3,9	5,3	6,7	8,2	9,6
	RGS-4+8	2,6	4,2	5,7	7,2	8,8	10,3
	RGS-6+6	2,6	4,2	5,7	7,2	8,8	10,3
	RGS-6+8	2,9	4,6	6,3	8,0	9,7	11,4
RGS-8+8	3,2	5,0	6,9	8,7	10,6	12,5	

RGP

MCT Brattberg has a series of round passages available under the product group RGP. The RGP penetrations were originally developed for the passage of pipes in ship's walls and in offshore applications. In addition, the RGP penetrations are used as passages in existing concrete walls, since the RGP can be mounted in a hole drilled on the right size without further aids. The RGP is a pressure water-tight penetration, which is also certified as fire retardant.

The following versions are available as standard from the RGP series:

- RGP 50
- RGP 70
- RGP 100
- RGP 125
- RGP 150
- RGP 200
- RGP 300



RGP100

Properties of the RGP

- A60 certified by Lloyds Register and DNV
- EN-1366 tested against fire penetration (integrity 120 min)
- Certified up to a pressure of 1.8 bar (with the exception of RGP 300)
- Tested to 4.5 bar (RGP 300: 4 bar)
- Resistant to gas, explosion, water, dust, vermin etc.
- Metal parts of the RGP are galvanized as standard (stainless steel available at extra cost)
- Sleeves available in (stainless) steel and aluminum, with and without flange, for surface mounting
- The RGP can be placed directly in an existing concrete wall

Sizes and dimensions

TYPE	INNER SIZE	MAX. CABLE DIAM. (with 1 cable)	OUTSIDE DIAM.	MARGINS
RGP 50	30 x 30 mm	24 mm	50 mm	50-51 mm
RGP 70	40 x 40 mm	34 mm	70 mm	70-71 mm
RGP 100	60 x 60 mm	54 mm	100 mm	100-102 mm
RGP 125	80 x 80 mm	54 mm	125 mm	125-127 mm
RGP 150	90 x 90 mm	74 mm	150 mm	150-152 mm
RGP 200	120 x 120 mm	100 mm	200 mm	200-202 mm
RGP 300	180 x 180 mm	168 mm	300 mm	301.5-304 mm

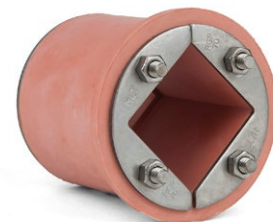
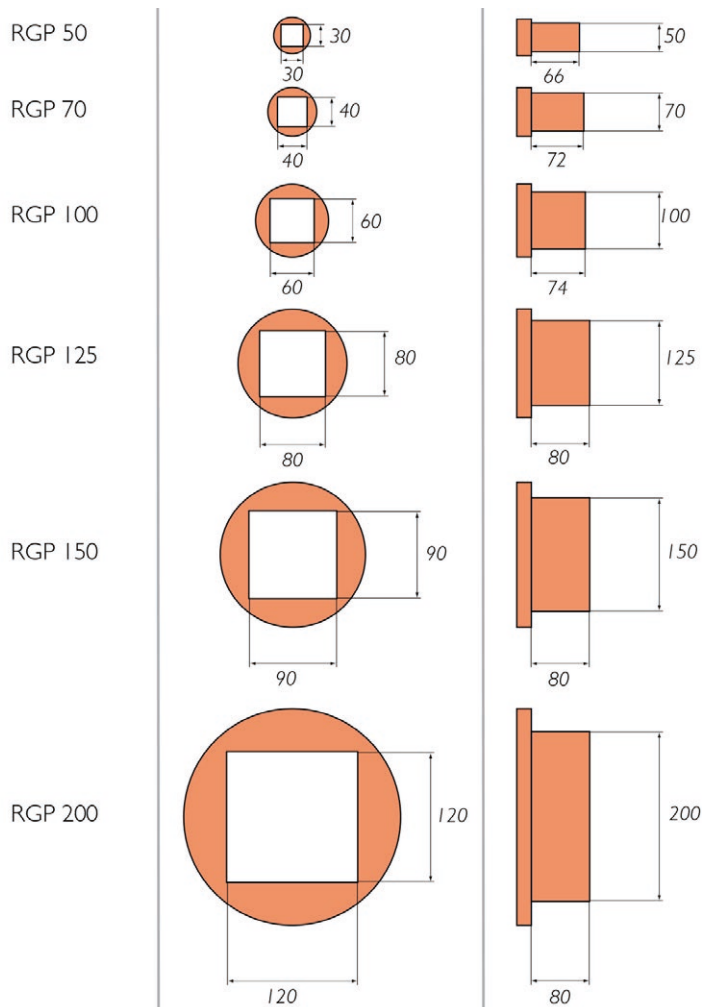

RGP70



Also available in EMC version

RGP SLEEVES

Frames and sleeves

Round frames and sleeves for the RGP windows for welding or casting into walls

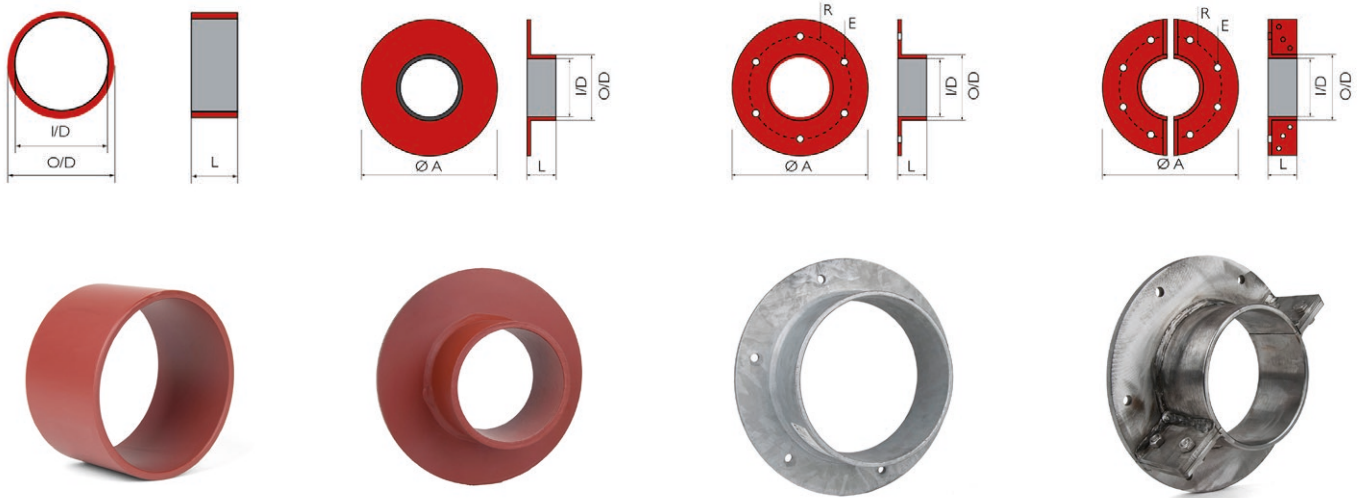

Type S without flange				
Type	O/D mm	I/D mm	L mm	Weight
S 50/L30	63	51 ¹⁾	35	0.3 kg
S 50/L60	63	51 ¹⁾	70	0.6 kg
S 70	83	71 ¹⁾	70	0.8 kg
S 100	114	102 ¹⁾	70	1.1 kg
S 125	140	128 ¹⁾	70	1.4 kg
S 150	164	152 ¹⁾	82	1.9 kg
S 200	214	202 ¹⁾	82	2.5 kg

¹⁾0 - 0.3mm

Type SFR with flange					
Type	O/D mm	I/D mm	L mm	A mm	Weight
SFR 50/L60	63	51 ¹⁾	73	145	1,2 kg
SFR 70	83	71 ¹⁾	74	185	2,1 kg
SFR 100	114	102 ¹⁾	74	215	2,7 kg
SFR 125	140	128 ¹⁾	74	240	4,0 kg
SFR 150	164	152 ¹⁾	86	264	4,0 kg
SFR 200	214	202 ¹⁾	86	315	5,1 kg

¹⁾0 - 0.3mm

Type SFR and SRFBO (open) with flange								
Type	O/D mm	I/D mm	L mm	A mm	R mm	E mm	no. of holes	Weight
SFRB (O) 50/L60	63	51 ¹⁾	73	145	52.5	9	4	1,2 kg
SFRB (O) 70	83	71 ¹⁾	74	185	68.0	9	4	2,1 kg
SFRB (O) 100	114	102 ¹⁾	74	215	82.0	9	4	2,7 kg
SFRB (O) 125	140	128 ¹⁾	74	240		9	4	4,0 kg
SFRB (O) 150	164	152 ¹⁾	86	264	108.0	11	6	4,0 kg
SFRB (O) 200	214	202 ¹⁾	86	315	132.0	11	6	5,1 kg

¹⁾0 - 0.3mm

RGB and RGG frames

MCT Brattberg has more than 60 years of experience in the development of high-quality cable and pipe penetrations. Basically, the system consists of transit windows and filling material, tailored to the quantity and size of cables and pipes to be fed through. The different types of RGB frames are intended for application in or on concrete walls. The RGB frame can be poured into a concrete wall / foundation or bolted afterwards.

The RGB and RGG frames are available in: stainless steel, primed mild steel, galvanized mild steel and aluminium.



RGB6X2F

RGB types

- RGB** The most commonly used frame type, in the base intended for casting in a concrete wal.
- RGG** Frame for lightweight walls. Very similar with an RGB frame, but with bolt holes and (optionally) a metal counterframe
- RGGOK** Developed for existing situations, with removable parts.



RGB



RGG



RGGOK

Installation RGG

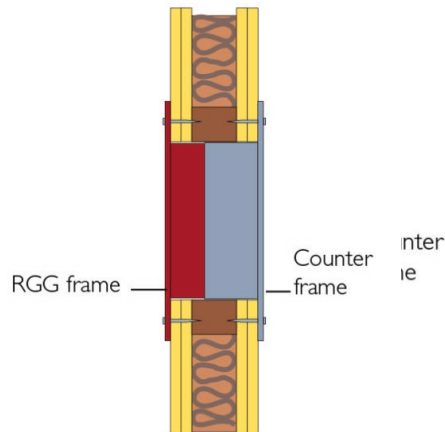
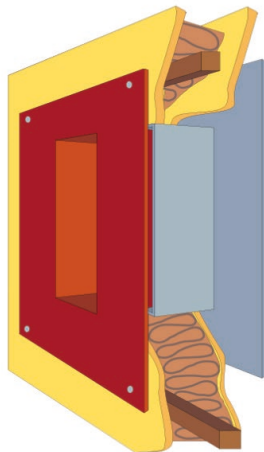

Installation RGB

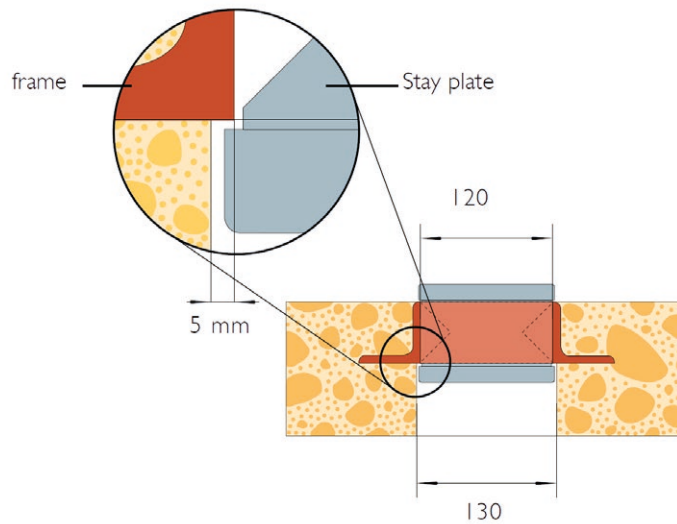
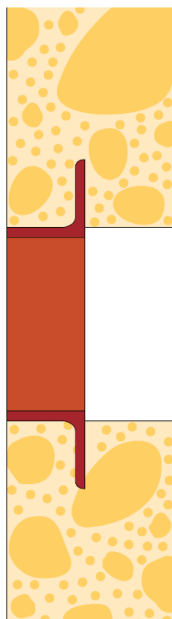

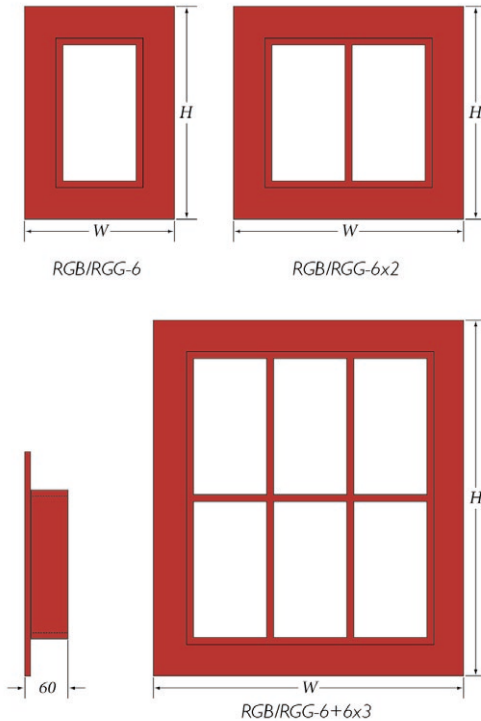

Maten

The RGB frame has a standard internal width of 120mm and is available in four height units: 2, 4, 6 and 8, from 100mm in 60mm steps up to 280mm internal height.

Window combinations can be created by combining different basic sizes in a combination window. This can be done in both width and height. For example, for a wide cable duct, an RGB6+6x3 can be used: a window with 6 openings with a height of 6 (2 high and 3 wide).

Sizes in mm

Frame size	H (Height)	W (Width)/ Multiple frames						x a
		x 1	x 2	x 3	x 4	x 5	x 6	
RGB/RGG-2	221	240,5	371	501,5	632	762,5	893	W=110 + 130,5 x a
RGB/RGG-4	279,5	-"-	-"-	-"-	-"-	-"-	-"-	
RGB/RGG-6	338	-"-	-"-	-"-	-"-	-"-	-"-	
RGB/RGG-8	396,5	-"-	-"-	-"-	-"-	-"-	-"-	
RGB/RGG-2+2	332	-"-	-"-	-"-	-"-	-"-	-"-	
RGB/RGG-2+4	390,5	-"-	-"-	-"-	-"-	-"-	-"-	
RGB/RGG-2+6	449	-"-	-"-	-"-	-"-	-"-	-"-	
RGB/RGG-2+8	507,5	-"-	-"-	-"-	-"-	-"-	-"-	
RGB/RGG-4+4	449	-"-	-"-	-"-	-"-	-"-	-"-	
RGB/RGG-4+6	507,5	-"-	-"-	-"-	-"-	-"-	-"-	
RGB/RGG-4+8	566	-"-	-"-	-"-	-"-	-"-	-"-	
RGB/RGG-6+6	566	-"-	-"-	-"-	-"-	-"-	-"-	
RGB/RGG-6+8	624,5	-"-	-"-	-"-	-"-	-"-	-"-	
RGB/RGG-8+8	683	-"-	-"-	-"-	-"-	-"-	-"-	

- a = number of frames in width
- Tolerance single frame: 3.5 mm
- Thickness of the material is 6 mm, except the inner horizontal and vertical walls in combination frames, these are 10 mm

Weight in kilogram								
W (Width)/ Multiple frames								
Material	Frame size	1X	2X	3X	4X	5X	6X	
Steel	RGB/RGG-2	3,1	5,0	6,9	8,8	10,7	12,6	
	RGB/RGG-4	3,8	5,9	8,1	10,2	12,4	14,6	
	RGB/RGG-6	4,4	6,8	9,2	11,5	13,8	16,3	
	SS en 10025- S235JRG2 DIN RST 37-2 BS4360 gr, 40 NS17100	RGB/RGG-8	5,0	7,7	10,4	13,1	15,8	18,5
	RGB/RGG-2+2	5,0	7,9	10,9	13,9	16,8	19,8	
	RGB/RGG-2+4	5,6	9,0	12,4	15,7	19,1	22,4	
	RGB/RGG-2+6	6,2	9,9	13,6	17,3	21,0	24,7	
	RGB/RGG-2+8	6,9	11,0	15,1	19,2	23,3	27,4	
	RGB/RGG-4+4	6,2	9,9	13,6	17,3	21,0	24,7	
	RGB/RGG-4+6	6,9	11,0	15,1	19,2	23,3	27,4	
	RGB/RGG-4+8	7,4	11,8	16,2	20,6	25,0	29,4	
	RGB/RGG-6+6	7,4	11,8	16,2	20,6	25,0	29,4	
	RGB/RGG-6+8	8,1	13,0	17,9	22,7	27,6	32,4	
RGB/RGG-8+8	8,9	14,2	19,5	24,9	30,2	35,5		
Stainless Steel	RGB/RGG-2	3,2	5,1	7,1	9,0	11,0	12,9	
	RGB/RGG-4	3,9	6,1	8,3	10,5	12,7	14,9	
	DIN 1,4404 ASTM/316 L AISI 316 L BS 970 gr, 316 S11 NS 14450	RGB/RGG-6	4,5	6,9	9,4	11,8	14,2	16,7
	RGB/RGG-8	5,2	7,9	10,7	13,5	16,2	19,0	
	RGB/RGG-2+2	5,1	8,1	11,2	14,2	17,2	20,3	
	RGB/RGG-2+4	5,8	9,2	12,7	16,1	19,6	23,0	
	RGB/RGG-2+6	6,3	10,1	13,9	17,8	21,6	25,4	
	RGB/RGG-2+8	7,1	11,3	15,5	19,7	23,9	28,1	
	RGB/RGG-4+4	6,3	10,1	13,9	17,8	21,6	25,4	
	RGB/RGG-4+6	7,1	11,3	15,5	19,7	23,9	28,1	
	RGB/RGG-4+8	7,6	12,1	16,6	21,1	25,6	30,1	
	RGB/RGG-6+6	7,6	12,1	16,6	21,1	25,6	30,1	
	RGB/RGG-6+8	8,4	13,3	18,3	23,3	28,3	33,3	
RGB/RGG-8+8	9,1	14,6	20,0	25,5	31,0	36,4		
Aluminium	RGB/RGG-2	1,1	1,8	2,5	3,1	3,8	4,4	
	RGB/RGG-4	1,4	2,1	2,9	3,6	4,4	5,1	
	RGB/RGG-6	1,6	2,4	3,2	4,1	4,9	5,7	
	EN AW6082 DIN ALMG SI I A 6082 BS H30/6082 TF NS17305	RGB/RGG-8	1,8	2,7	3,7	4,6	5,6	6,5
	RGB/RGG-2+2	1,8	2,8	3,9	4,9	5,9	7,0	
	RGB/RGG-2+4	2,0	3,2	4,4	5,5	6,7	7,9	
	RGB/RGG-2+6	2,2	3,5	4,8	6,1	7,4	8,7	
	RGB/RGG-2+8	2,4	3,9	5,3	6,7	8,2	9,6	
	RGB/RGG-4+4	2,2	3,5	4,8	6,1	7,4	8,7	
	RGB/RGG-4+6	2,4	3,9	5,3	6,7	8,2	9,6	
	RGB/RGG-4+8	2,6	4,2	5,7	7,2	8,8	10,3	
	RGB/RGG-6+6	2,6	4,2	5,7	7,2	8,8	10,3	
	RGB/RGG-6+8	2,9	4,6	6,3	8,0	9,7	11,4	
RGB/RGG-8+8	3,2	5,0	6,9	8,7	10,6	12,5		

RGGOK

Based on practical experience in the Dutch market, MCT Brattberg developed the frame RGGOK. This new, modular window has been specially developed for existing situations where customization is required. The frame is similar to the RGO, but because of the extra depth stayplates and end seals can be easily placed. Thanks to the notches in the frame, the seal is completely in the RGGOK and it is not necessary to cut a piece of the wall away. Irrespective of the existing situation and the existing cables, in most cases, the transit point can be made permanently watertight with the help of the RGGOK.

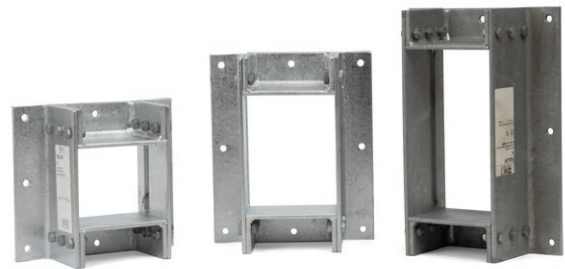

Applications

The RGGOK frame is intended for use in existing situations. In essence, it is a frame that has to seal the existing through hole in a wall or floor. Often in existing situations there are cables that can not or can not be removed, while at the same time there is a transit point that is insufficiently watertight or fire retardant. Sometimes there is also the need to attach a few cables. In all cases it must be determined with what size RGGOK window the throughput space can be completely sealed, while at the same time the cable numbers, diameters and positions have to be mapped. On the basis of that inventory, the correct type of RGGOK window can be determined. Our advisors are happy to view the situation on site, if necessary, to be able to give good advice.

Sizes

The RGGOK window has the same internal width as the standard RGB windows (120mm) and is also available in four height units: from 100mm in steps of 60mm up to 280mm internal height. In addition, there are multiple windows, allowing expansion in the horizontal direction.

Options

The RGGOK is supplied as standard in galvanized steel, but it is also possible to order the frames in stainless steel.

The RGGOK comes standard with bolt holes (M8). If required, a customized hole pattern can be supplied. The required liquid packing is also available from Theunissen Technical Trading BV.



RGPM

The RGPM is specially designed for environments under or in close proximity to water and withstands a continuous pressure of up to 15 bar.

A special version of the RGPM has been developed for offshore windmills for the introduction of the J-tube below the waterline.

Successfully tested against continuous pressure

Test pressure 23 bar

Working pressure up to 15 bar

Based on your situation

Each RGPM is made for the specific situation and customer, so that per sealing, it can be determined how many cables or pipes must be fed, with the diameter varying from 50 to 200 mm. The outside diameter of the RGPM must match the inside diameter of the pipe or hole.

An RGPM is normally made with Nitrile rubber, but other materials are also possible in consultation. The cover plates are galvanized or made of stainless steel, but here too customer-specific requirements are possible.

Tested and certified

The RGPM windows are carefully tested beforehand in MCT Brattberg's own laboratories. The RGPM has been successfully tested at a pressure of 23 bar. Based on this, the standard RGPM is approved for use at a continuous pressure of 15 bar. For deviating RGPM solutions the pressure density depends on the execution. We are happy to advise you on customized solutions based on this pressure penetration.

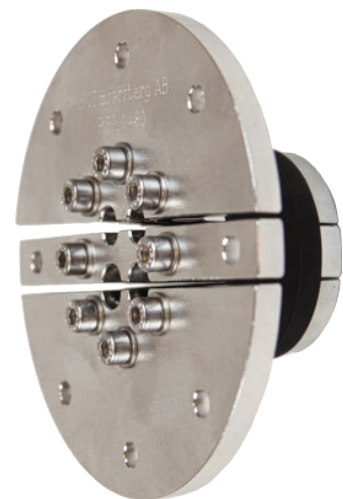

J-tube

RGPH

Specially for the implementation of cables in deep water, for example offshore installations and between different areas of submarines, MCT Brattberg developed the RGPH. The RGPH windows are resistant to very high pressure and individually seal several cables of different sizes. The number and size of the cables can be easily changed, thanks to the modular construction system.



- Suitable for offshore installations, drilling platforms and submarines
- Resistant to extremely high pressure (successfully tested up to 100 bar)
- High quality steel housing
- Pressure-proof applications may be far below sea level

High-quality transit system that meets all requirements

MCT Brattberg is the founder of high-quality, modular cables and cables pipes. The transits are (pressure) waterproof, gas-tight and fire-retardant. With a good one assembly therefore the products meet the required requirements. When a certain situation still requires a more specific solution, then the manufacturer is able to provide customization, tailored to the wishes and requirements of the customer or from the described environment situation.

Tested and certified

The RGPH is regularly applied to the construction of submarines and, for example, in the legs of drilling platforms. Each RGPH is carefully tested in its own laboratories before the window is delivered. The RGPH is approved for pressure up to 40 bar with a Type Approval from DNV. To this end, the RGPH was successfully tested at a pressure of no less than 100 bar.

Successfully tested , DNV type approval

Testing pressure 100 bar

Working pressure up to 40 bar

Ultrasonic tests of the flange

Dimensional and visual test of all details

Welding Procedures Specifications (WPS)

RFCS cabinet transit

RFCS is the name of MCT Brattberg's new cabinet transit, an innovative modular frame that has been specially designed as an alternative to swivels and plugs in (sheet steel) mounting boxes. Due to the modular construction, the dust and watertight penetration is easy to reopen to, for example, to feed an extra cable.

The RFCS is available in the lengths 10, 12 and 16 cm. In addition, double windows are available for these three lengths, so that with a standard height of 40 mm a double throughput length of 20, 24 and 32 cm is created.

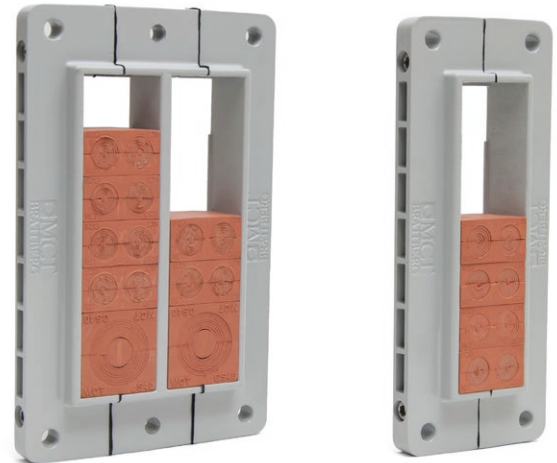

Advantages RFCS

- Space saving compared to conventional plugs and cable glands
- The end seal PTG-40, which can be installed from both sides, provides an IP65/67 protection (for this all blocks and end seal PTG-40 must be greased with MCT Brattberg lubricant)
- Easy installation with ready-to-use kits including gasket and mounting material.

The RFCS kit contains:

- Modular frame
- MCT Brattberg CS blocks marked with cable diameter (on the inside of each insert)
- End seal (PTG-40)
- Gasket for sealing the frame on the cabinet
- Complete set of mounting materials
- Lubricant



Dimensions

	<p>RFCS10 Packing space: 100x40mm Cutout: 55x145mm</p>		
	<p>RFCS12 Packing space: 120x40mm Cutout: 55x165mm</p>		
	<p>RFCS16 Packing space: 160x40mm Cutout: 55x205mm</p>		
	<p>RFCS20 Packing space: 200x40mm Cutout: 100x145mm</p>		
	<p>RFCS24 Packing space: 240x40mm Cutout: 100x165mm</p>		
	<p>RFCS32 Packing space: 320x40mm Cutout: 100x205mm</p>		

ALF cabinet transit

The ALF cabinet seal is a cable transit for carrying a large number of cables, dust and watertight, on a small surface. It is also possible to implement connectors and couplings. The ALF cabinet seal is locked with two bolts with the aid of an Allen key and is easy to open again, to replace or add cables.

The Blocks

The cables are individually sealed with 30 mm long EPDM insert blocks. These blocks are available separately for each diameter (similar to standard MCT Brattberg blocks). The special Add blocks (suitable for 5 different cable diameters) can also be used to implement even more flexibly.



Advantages ALF seal

- All cables through one opening (also with connector)
- Run many cables on a limited surface
- Unknown cable diameter beforehand is not a problem
- Easily change / add cables afterwards
- Dust and waterproof (IP67)
- Assembly without special tools
- For cables with a diameter of 3 mm to 54 mm
- Supplied complete with gasket, bolts and nuts

Applications

- Trains and trams (wagons)
- Switch boxes
- Computer cases
- Telecommunication houses
- Industrial installations

Versions

- Aluminium frame
- Standard dimensions or customized
- Standard 30mm insert or Add blocks
- Delivery complete with gasket, bolts and nuts

Available certificates

- IP 67 according to IEC / EN 60529
- UL 50 test certificate
- UL94 test certificate (approved for class V0)
- NEMA, Type 3R & 4X & 12

Inside sizes (packing space)

- 150 x 60 mm
 - 120 x 60 mm
 - 90 x 60 mm
 - 60 x 60 mm
- Also custom sizes available!

Sizes



ALF-90
packing space:
90x60mm

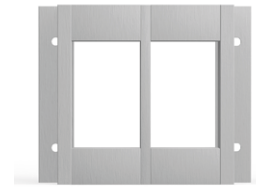

ALF-90X2
packing space:
2x 90x60mm



ALF-120
packing space:
120x60mm



ALF-120X2
packing space:
2x 120x60mm



ALF-150
packing space:
150x60mm



ALF-150X2
packing space:
2x 150x60mm



ALF-180
packing space:
2x 90x60mm



ALF-180X2
packing space:
4x 90x60mm



ALF-240
packing space:
2x 120x60mm



ALF-240X2
packing space:
4x 120x60mm



ALF-300
packing space:
2x 150x60mm



ALF-300X2
packing space:
4x 150x60mm

SR cable gland (welding)

MCT Brattberg supplies a pressure-resistant, round cable transit that is suitable for waterproofing feeding a pipe or cable from 4 to 100 mm: the SR Seal. The SR Seal consists of a galvanized steel or stainless steel sleeve and a round element for filling. The steel sleeve is intended to be inserted into a fitting round hole in a steel wall or deck.

The filling element is made of silicone rubber and finished with galvanised steel mounting parts. The rubber of the SR Seal consists of a core and 1 or more round rings, which can be removed to be able to seal the cable(s). If the core is not removed, the SR Seal can also be used as a blind lead-through, for example to feed a cable or pipe in the future.



The most important properties of the SR Seal:

- A60 certified by Lloyds Register in accordance with IMO 754 (18)
- Tested to a water pressure of 5 bar
- Resistant to water, dust, ice formation, vermin, etc.
- Metal parts of the SR Seal are made of galvanized steel
- Sleeves are included to be able to weld the penetration into a wall
- Different sizes on request

Sizes

The SR Seal is available in eight sizes. After the SR Seal is made suitable for the cable to be fed through, by removing the core and possibly one or more rubber rings around the core, the cable can be easily fixed by tightening the Allen screws that are on the round filler element.

To feed existing cables, the rubber parts of SR Seal can be supplied cut-in, or can be opened on site with a punch knife.

SR Type	Cable diameter		Sleeve Ø (mm)
	Min (mm)	Max (mm)	
SR 25	6	12	33.4
SR 38	11	24	48.3
SR 38-2	6 (2x)	12 (2x)	48.3
SR 38-3	6 (4x)	12 (4x)	48.3
SR 49	20	32	60.3
SR 62	30	42	73
SR 77	40	52	88.9
SR 102	50	70	114.3
SR 125	65	85	140
SR 150	80	100	168.3

MSR cable gland (no welding)

The MCT Brattberg MSR cable gland is a pressure-resistant cable gland, tested up to 5 bar, developed for the rapid entry of cables or pipes in an existing steel wall. In addition to being pressure-resistant, the MSR swivel is also A60 fire-retardant. To apply the MSR cable gland, only a hole has to be drilled to size in the steel wall or floor. There is no need for welding, which saves a lot of time. The MSR cable gland is made in galvanized steel or in stainless steel on request.



The MSR cable gland is available in ten standard variants. Deviating sizes are available in consultation. The MSR cable glands range is suitable for cables from 4 to 32 mm. In addition to cable glands for single cables, cable glands for multiple cables (maximum 8) are also available.

Features of the MSR cable gland:

- Multiple swivel for sealing cables in steel walls or decks, without the need for welding
- A60 certified by Lloyds Register in accordance with IMO 754 (18)
- Tested to a water pressure of 5 bar
- Resistant to water, dust, ice formation, vermin, etc.
- Metal parts of the MSR Gland are made of stainless steel
- The MSR sleeve is made of galvanized steel (stainless steel on request)
- Alternatives are also available in addition to standard sizes

The MSR cable gland consists of a steel housing with screw thread, a gasket, a sealing nut and a filling element. The filling element is made of silicone rubber and finished with steel mounting parts. The rubber of the MSR cable gland consists of a core, or a few cores, and 1 or more round rings, which can be removed in order to be able to properly seal the cable (s). If the core is not removed, the MSR cable gland can also be used, partially or completely, as a blind lead-through.

After the MSR cable gland has been made suitable for the cables to be fed through, by removing each core and possibly one or more rubber rings around the core, the cables can be easily fixed by tightening the Allen screws that are located on the round filler element.

To feed through existing cables, the rubber parts of MSR cable gland can be supplied cut-in, or opened on site with a punch knife.

Type	Cable diameter (mm)		No. cables
	Min	Max	
MSR 20-1	4	12	1
MSR 40-1	11	24	1
MSR 40-2	6	15	2
MSR 40-3	6	12	4
MSR 50-1	4	10	5
MSR 50-2	4	16	3
MSR 50-3	20	32	1
MSR 63-1	4	16	4
MSR 63-2	4	10	8
MSR 63-3	22	32	1

MSR GLANDS

SEAL TYPE	CABLE ENTRIES	(A) CENTRE PLUG RANGE	(B) MIDDLE RING RANGE	(C) LAST RING RANGE
MSR20 TYPE 1 SEAL (1 x 4-12)	1	4 - 6 mm	6 - 12 mm	n/a
MSR40 TYPE 1 SEAL (1 x 11-24mm)	1	12 - 18 mm	18 - 24 mm	n/a
MSR40 TYPE 2 SEAL (2 x 6-15mm)	3	6 - 9 mm	9 - 15 mm	n/a
MSR40 TYPE 3 SEAL (4 x 6-12mm)	4	6 - 12 mm	n/a	n/a
MSR50 TYPE 1 SEAL (5 x 4-10mm)	5	4 - 10 mm	n/a	n/a
MSR50 TYPE 2 SEAL (3 x 4-16mm)	3	4 - 10 mm	10 - 16 mm	n/a
MSR50 TYPE 3 SEAL (1 x 20-32mm)	1	20 - 26 mm	26 - 32 mm	n/a
MSR63 TYPE 1 SEAL (4 x 4-16mm)	4	4 - 10 mm	10 - 16 mm	n/a
MSR63 TYPE 2 SEAL (8 x 4-10mm)	8	4 - 10 mm	n/a	n/a

SR GLANDS

SEAL TYPE	CABLE ENTRIES	(A) CENTRE PLUG RANGE	(B) MIDDLE RING RANGE	(C) LAST RING RANGE
SR25 SEAL (1 x 4-12mm)	1	4 - 6 mm	6 - 12 mm	n/a
SR38-1 SEAL (1 x 11-24mm)	1	12 - 18 mm	18 - 24 mm	n/a
SR38-2 SEAL (2 x 6-15mm)	2	6 - 9 mm	9 - 15 mm	n/a
SR38-3 SEAL (4 x 6-12mm)	4	6 - 12 mm	n/a	n/a
SR49 (1 x 20-32mm)	1	20 - 26 mm	26 - 32 mm	n/a
SR62 (1 x 30-42mm)	1	30 - 36 mm	36 - 42 mm	n/a
SR77 (1 x 40-52mm)	1	40 - 46 mm	46 - 52 mm	n/a
SR102 (1 x 50-70mm)	1	50 - 57 mm	57 - 64 mm	64 - 70 mm
SR125 (1 x 65-85mm)	1	65 - 72 mm	72 - 78 mm	78 - 85 mm
SR150 (1 x 80-100mm)	1	80 - 87 mm	87 - 94 mm	94 - 100 mm

Deck & Bulkhead Gland

MCT Brattberg has developed a flameproof penetration for the feeding of a few cables by ship's walls, where no welding work is required.

The Deck & Bulkhead Gland is made of galvanized steel and is available in 2 lengths and with 2 lengths of thread. In total there are 4 basic variants; 6 different sizes are available for each basic variant (M16 to M60).

The different lengths of both the swivel tube and the thread are normally selected on the basis of the thickness of the insulating layer present on the wall. Cables that are carried through can vary from 4 to 60 mm.

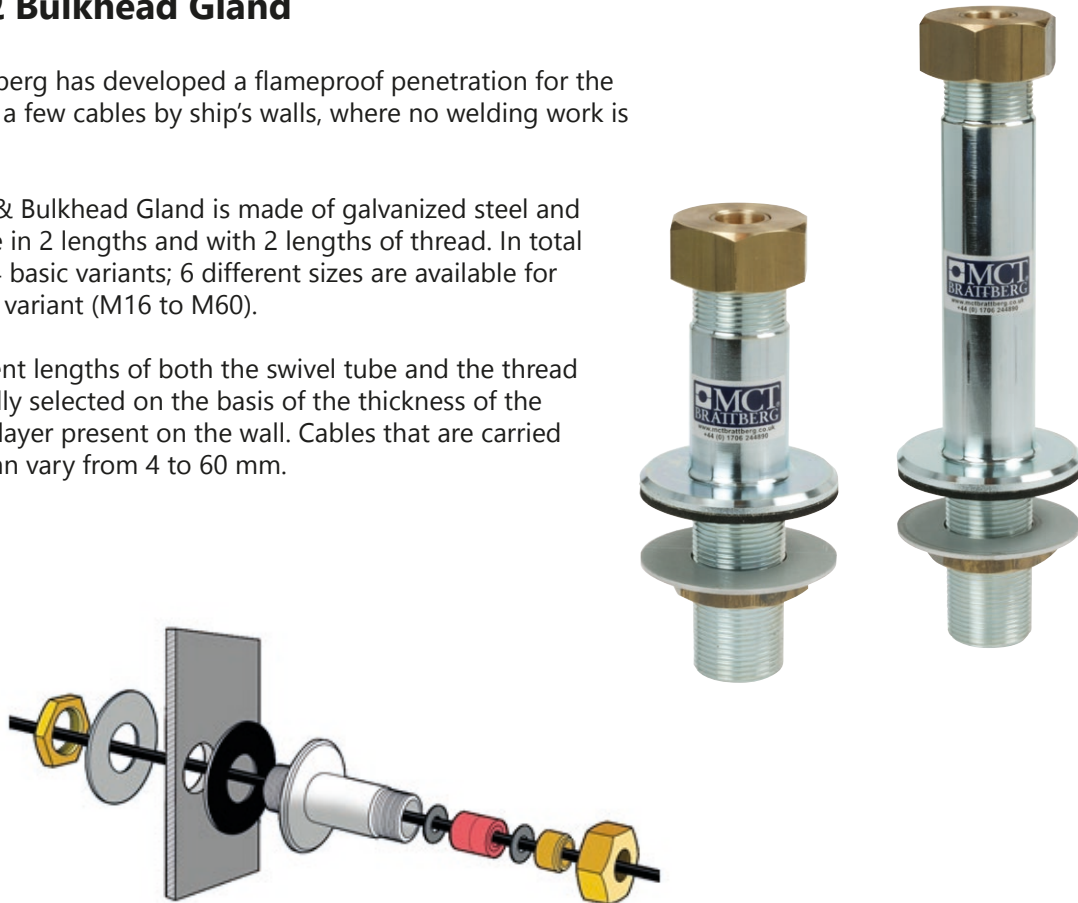

Features of the Deck & Bulkhead Glands:

- A60 certified by Lloyds Register in accordance with IMO 754 (18)
- Tested to a water pressure of 10 bar
- Resistant to water, dust, fire and pressure
- Equipped with soft rubber core for flexible cable routing
- Housing is available in 4 types (different in total length and length of thread)
- There are no additional parts or specific work for assembly (such as welding) necessary
- NATO Stock coding available
- Certified according to DEF STAN 07-225 / 1 (previously NES 510)

Sizes and dimensions

	Min. reach cable (mm)	Max. reach cable (mm)	Metric screw thread	Flange diameter (mm)	Bolt	Weight (kg)
150mm gland with 30mm long thread						
D&B 16-150-30	4	16	M33x2	70	46	1,5 kg
D&B 25-150-30	13	25	M50x2	80	65	2,6 kg
D&B 35-150-30	23	35	M60x2	100	80	3,5 kg
D&B 50-150-30	32	50	M75x2	120	100	5,1 kg
D&B 60-150-30	48	60	M90x2	150	120	7,4 kg
150mm gland with 70mm long thread						
D&B 16-150-70	4	16	M33x2	70	46	1,6 kg
D&B 25-150-70	13	25	M50x2	80	65	3,0 kg
D&B 35-150-70	23	35	M60x2	100	80	4,1 kg
D&B 50-150-70	32	50	M75x2	120	100	5,7 kg
D&B 60-150-70	48	60	M90x2	150	120	8,1 kg
75mm gland with 30mm long thread						
D&B 16-75-30	4	16	M33x2	70	46	1,0 kg
D&B 25-75-30	13	25	M50x2	80	65	1,8 kg
D&B 35-75-30	23	35	M60x2	100	80	2,5 kg
D&B 50-75-30	32	50	M75x2	120	100	3,6 kg
D&B 60-75-30	48	60	M90x2	150	120	6,2 kg
75mm gland with 70mm long thread						
D&B 16-75-70	4	16	M33x2	70	46	1,2 kg
D&B 25-75-70	13	25	M50x2	80	65	2,2 kg
D&B 35-75-70	23	35	M60x2	100	80	2,9 kg
D&B 50-75-70	32	50	M75x2	120	100	4,2 kg
D&B 60-75-70	48	60	M90x2	150	120	6,9 kg

Accessoires

MCT Brattberg has designed a number of accessories to make filling and opening the frames easier:



PACKING TOOL

- Makes installation easier
- Keep cables and blocks in place during installation
- Ideal for use before the frame is completed with endpacking

QUICK RELEASE SPANNER

- Faster and easier installation by quick release function
- Compact 24mm grip improves access of compression bolt
- Easy to use



BLOCK SELECTOR

- Easy re-entry into system
- Ideal for use together with quick release spanner
- Smoother disassembly of end packer without unnecessary damages

ACCESSOIRES



CABLE SEPARATOR

- To aid installation of insert blocks by keeping away the interference of cables
- Divides cables in different rows
- Easy to use

SPACER TOOL

- Simplifies insertion of last row of blocks between two stay plates
- Saves time by smoother installation
- Easy to use



BLOCK SELECTOR

- Helps you to choose the right insert block.
- For measuring of cables from 4 to 48 mm in diam.
- Easy to use and easy to carry.

TWEEZER

- Assist insertion of last EMC block in each row
- Protect the copper sheets from damage during insertion of block
- Contribute to a functional EMC transit





EMC MARKING TEMPLATE

- Simplifies placement of marking where the cable sheath shall be cut
- Ensures that cables are positioned correctly in the blocks
- Contribute to a functional EMC transit

LUBRICANT

- Simplifies insertion of blocks
- Saves time by smoother installation
- Ensures a watertight seal



CCM150 / CCM200

- Casting modules
- Creates (temporary) watertight seal
- Perfect for RGP150 and RGP200

PROJECTS



Maeslantkering

Project **Maeslantkering**
Client **Rijkswaterstaat**
Transits **RGP**

Helios

Project **CSD Helios**
Client **Boskalis**
Transits **RGS lasframes**

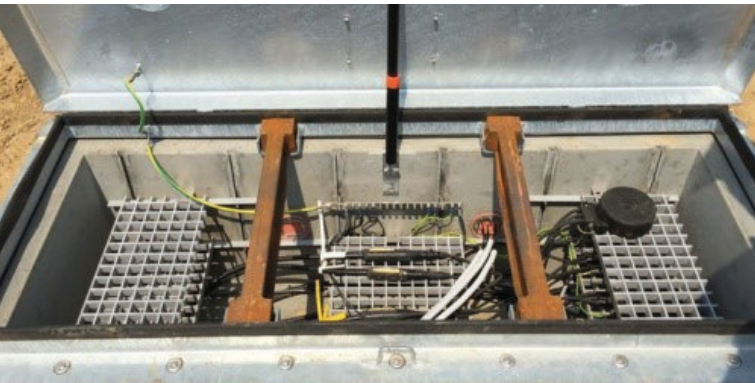

Brussels airport

Project **Renovation Brussels Airport**
Client **Brussels Airport**
Transits **RGP**

Laagspanningsruimte Railcenter

Project **Laagspanningsruimte Railcenter**
Client **Railcenter Amersfoort**
Transits **RGP**



PROJECTS



Maastricht Aachen Airport

Project **Maastricht Aachen Airport**
Client **Maastricht Aachen Airport**
Transits **RGPO**

Prinses Beatrixsluis

Project **Prinses beatrixsluis**
Client **Rijkswaterstaat**
Transits **RGP**

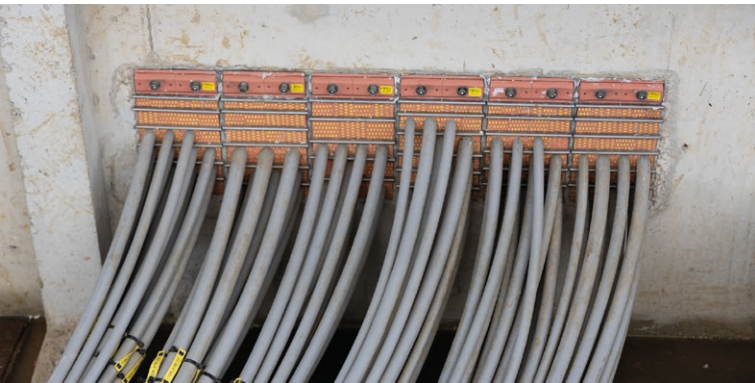

150kV net Boxmeer - Venray

Project **Upgrade 150 kV-net between Boxmeer-Venray**
Client **Tennet**
Transits **EMC transits
RGB casting frames**

Spartacus

Project **CSD Spartacus**
Client **DEME**
Transits **RGS and RGSbtb**



[More projects on mct.nl](https://www.mct.nl)